

the evolution of waterplay



COMMERCIAL POOL Product Manual

wibit™



90064-V04 - Product_manual_commercial_pool_3

All rights reserved © Wibit Sports GmbH - The content of this document, particularly text, photographs and drawings, is protected by copyright. Wibit Sports GmbH owns exclusive exploitation rights, unless labeled otherwise. A reproduction, even in extracts, is strictly forbidden.

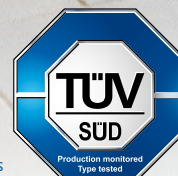

1. PRODUCT SETUP	3
2. SPECIAL PRODUCT SETUP HighRoller, Dome, Trampoline, Flip, L-Connect & R-Connect, Springboard, WiggleDiscs & Wiggle Start Block NM, Step & Step 6	9
3. ANCHORING bungees, pool booms, anchor sacks	21
4. REPAIRS	25
5. CLEANING, FOLDING & STORAGE	28
6. PICTOGRAM EXPLANATION	30
7. WARNINGS	31
8. SPECIFICATIONS	32

The following instructions show how to set up your Wibit products.



- Before setting up and using: Ensure to read all product manuals provided

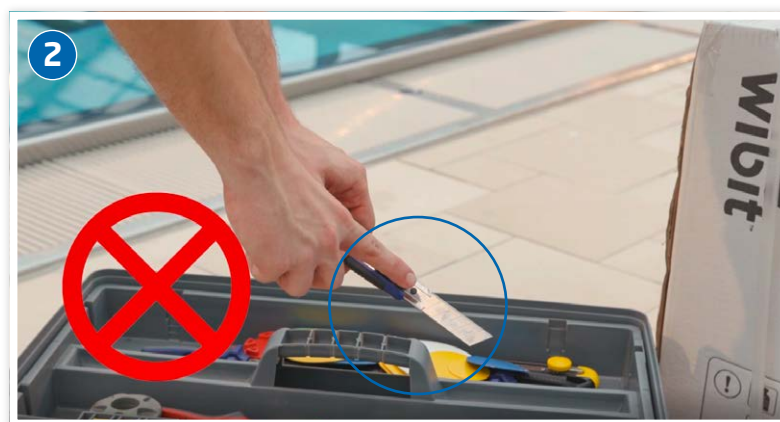

- Make sure you use a short enough blade when cutting the box open!



- Cut along the side flaps first. Make sure you lift the box top enough so the blade can't hit the product inside the box when you cut the middle part.

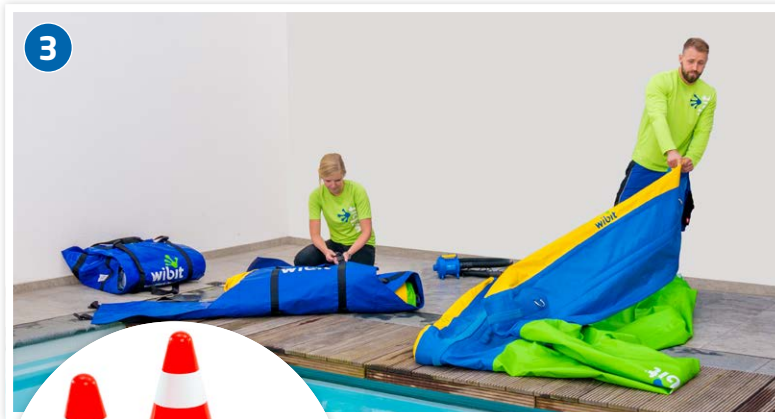

- Unpack the products

! Close off the area where the Wibit will be inflated to prevent guests from entering the area while set-up is occurring.

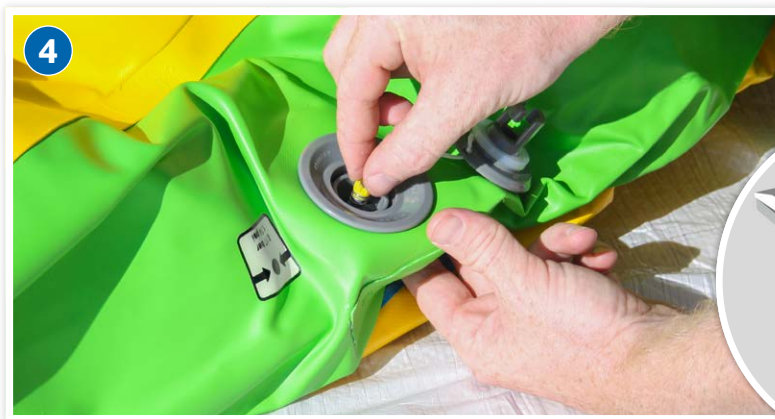

- Open all valves

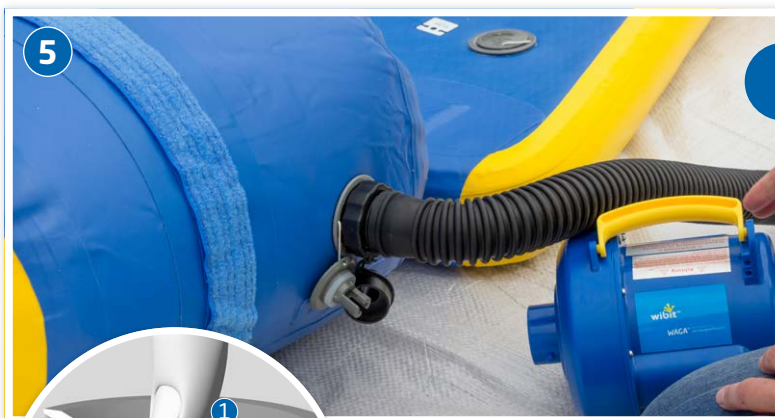

! The electric pump has an overheat protection. If it turns off (after approx. 15-20 minutes), please make sure to wait 20-30 minutes to let it cool off.

- Inflate the products with electric pump
- Ensure the pump is standing on a clear and clean ground (e.g. no water closeby)



! Close valve immediately after removing the hose of the electric pump.

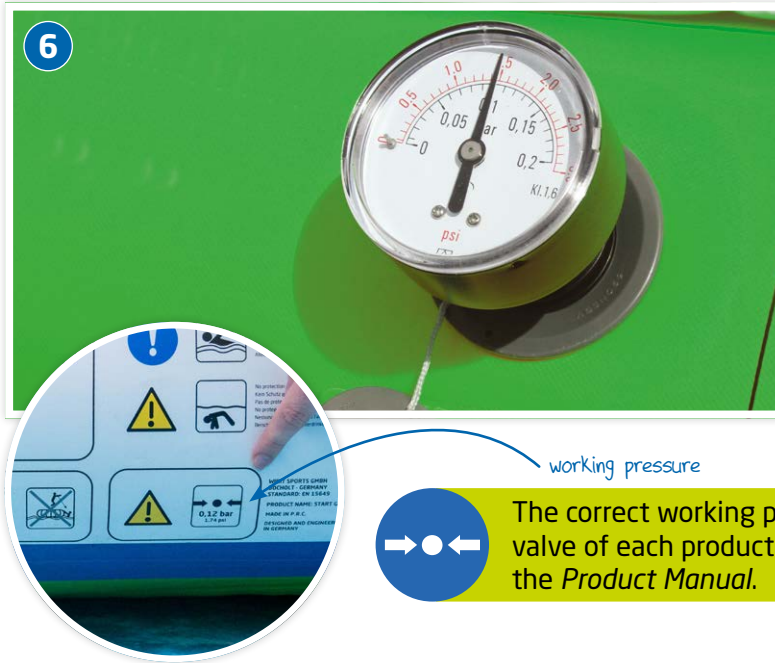

- Check working pressure with manometer

The correct working pressure can be found next to the valve of each product and in the SPECS section at the end of the *Product Manual*.



- Fill with hand pump if the correct working pressure is not achieved yet
- Keep the valve closed for this

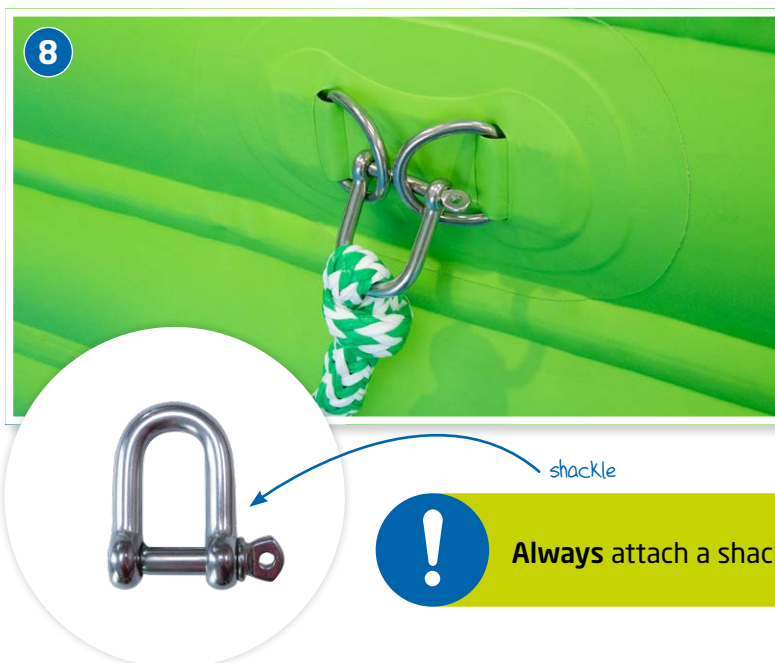

- Ensure that the bungees are pre-attached before carrying into water!
- Remove bungees from all products that are not anchored.

! Always attach a shackle to connect a bungee with a product.



Attention: Never open the knots of a bungee as it is not possible to tie them together again!



- All Wibit bungees come with a pre-attached shackle on one end.
- Make sure you always attach the shackle side of the bungee to the product.



Note: should you want to attach an additional shackle to the other side of the bungee, make sure you use the correct loop!





- Carry products to the water
- Use more than one person to avoid damage to the product!



Attention: Do not drag the products on the ground!



Dragging the products on the ground may cause severe defects!

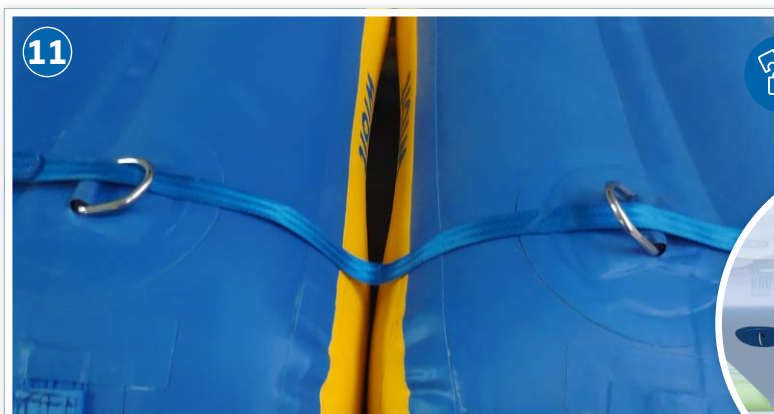

Each blue section has two D-ring connection plates.

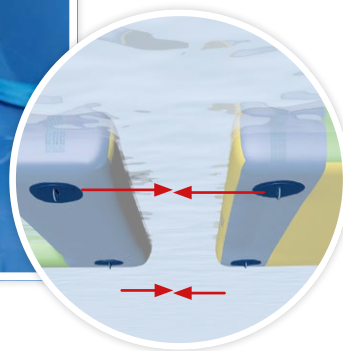

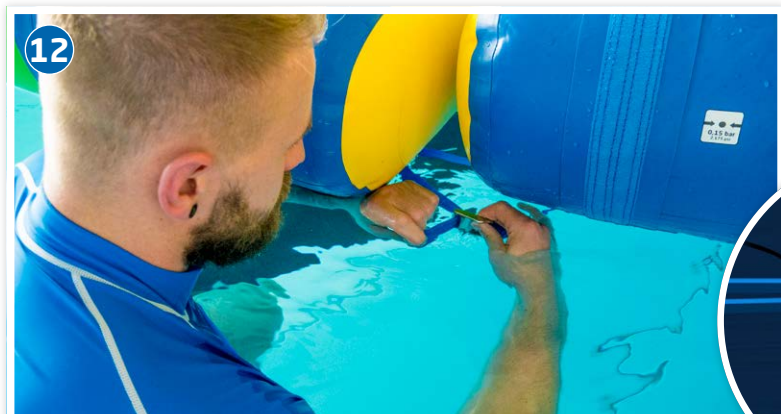

- Connect products in the water using the connector straps



- Cover the two blue sections using the safety flap



the middle of the safety flap and the product is marked with arrows

! Line up the arrows of the safety flap with those on the blue section to position correctly.



There are some Wibit products with special features that need extra attention during setup. Some of these products have more than one air chamber.



- The required working pressure for each air chamber can always be found right next to the valve
- Regularly check the air pressure of the inflated products in order to avoid underinflation caused by hot temperatures

! It is important that all valves are opened before inflating the products to avoid damage!



- Some products have a pressure relief valve to avoid over inflation in case of drastic changes in air temperature
- These valves are not relevant for the product setup
- To find out which products have a pressure relief valve please refer to the SPECS section in this manual

HIGHROLLER

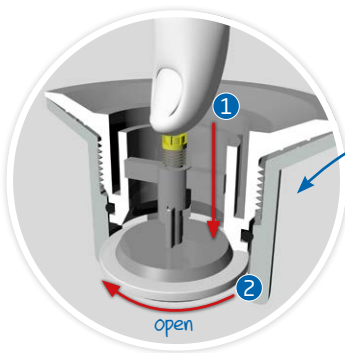

! All six valves must be opened before inflating the HighRoller!

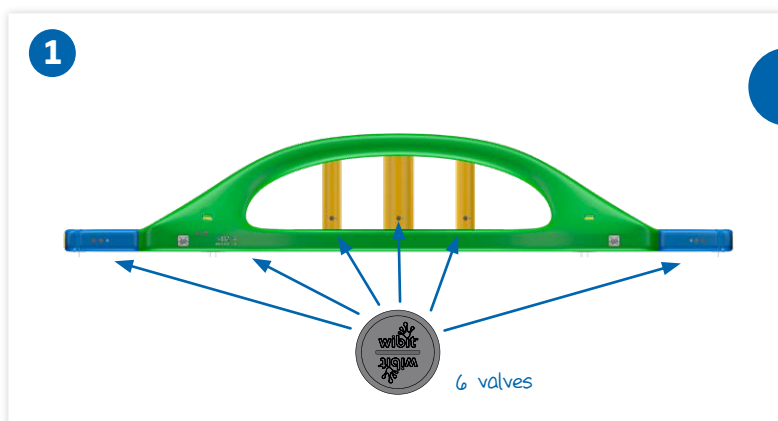

! It is important to follow the right order when inflating the different air chambers!

- Air chambers:**
1. blue sections
 2. green bridge
 3. yellow tubes

- Inflate all air chambers up to 100%

DOME



! It is important to follow the right order when inflating the different air chambers!

Air chambers:

1. green body with blue sections
2. yellow pillow

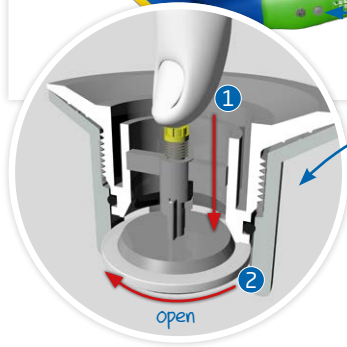

! All two valves must be opened before inflating the Dome!



- Inflate the green body with the blue sections up to 100%

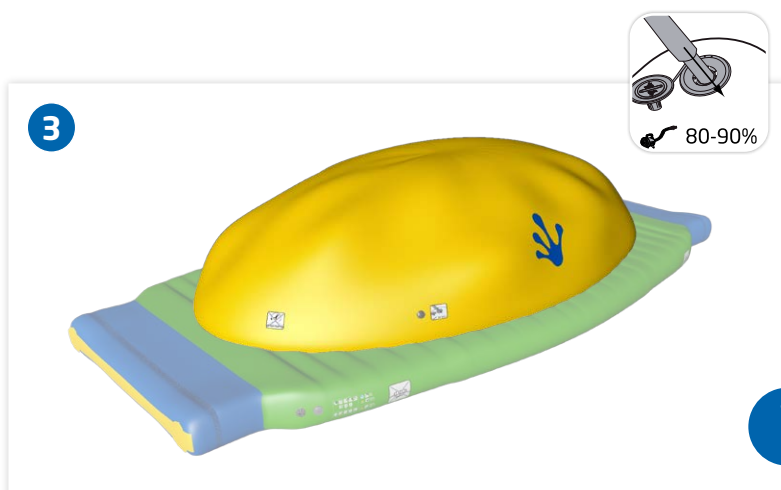

- Inflate the yellow pillow **only up to 80-90 %** in order to avoid damage!

! Do not fully inflate the yellow pillow!

TRAMPOLINE 2 AND TRAMPOLINE 4

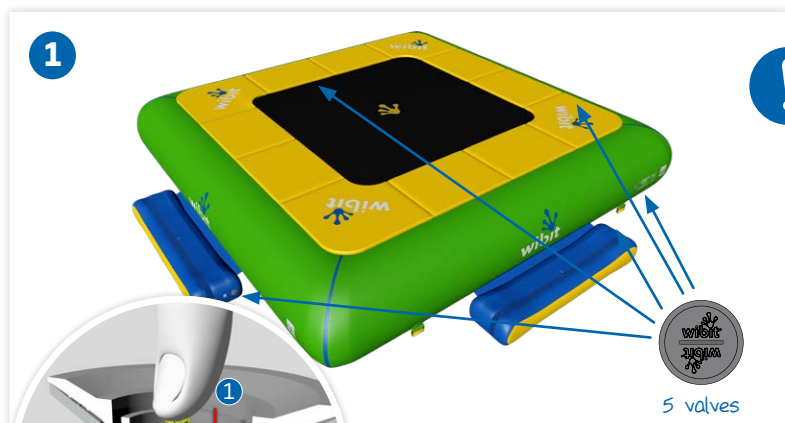

! It is important to follow the right order when inflating the different air chambers!

Air chambers:

1. blue sections
2. tube

! All five valves must be opened before inflating the Trampoline!



! Inflate the Trampoline tube **until 80%** of the required working pressure is achieved

! Do not fully inflate the tube!

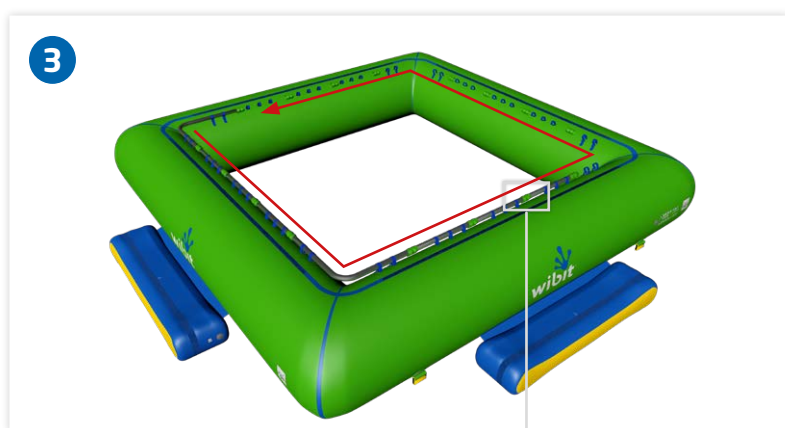

- Start by installing a corner piece in the webbing straps provided
- Make sure the webbing straps are only loosely fastened
- Mount the straight frame pieces in the correct order
- The frame pieces have to be plugged together (3a) and fastened with the help of the screws (3b)
- Cover the connection points using the green protector (3b)

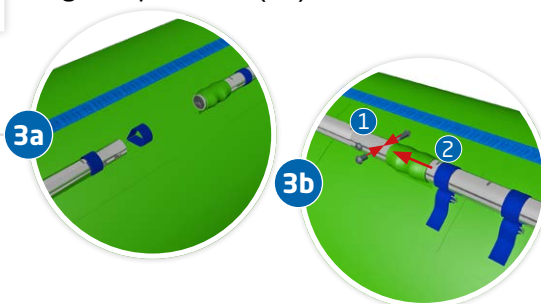



- Continue to connect the frame pieces working in one direction around the Trampoline
- When you are ready to slot the final corner piece you will need to force them away from each other before they can be slotted together

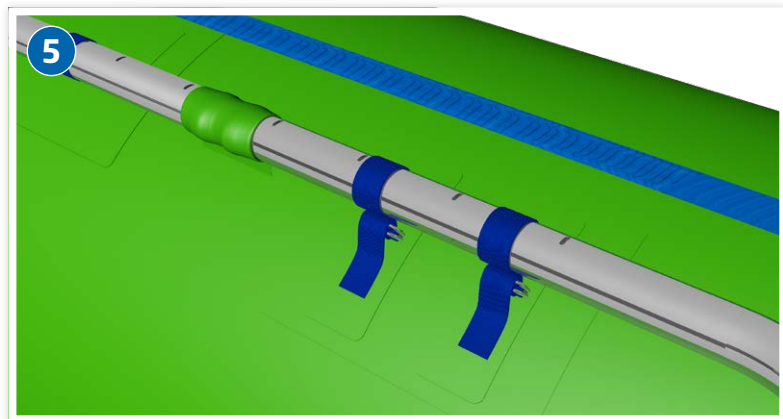

- Once each frame piece is installed, make sure all straps are pulled tight
- Make sure to regularly check that the straps are tight

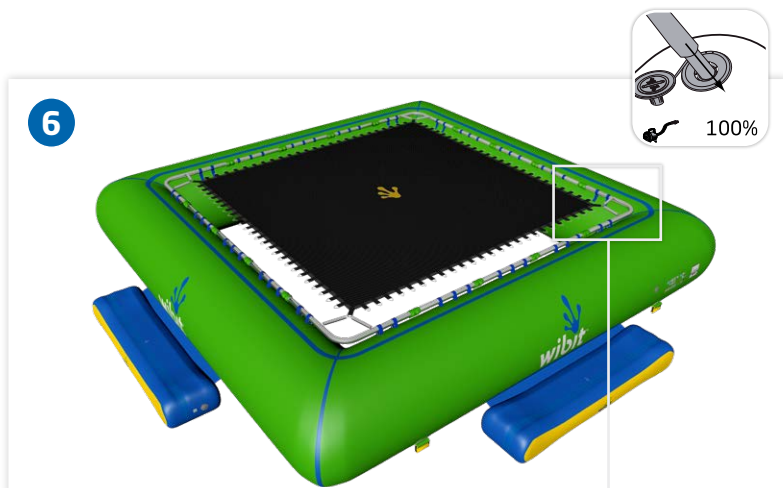

- Inflate the Trampoline tube until 100% of the required working pressure is achieved
- Make sure to regularly check the air pressure
- Connect the corners of the jumping mat to the corners of the Trampoline frame using two springs for each corner



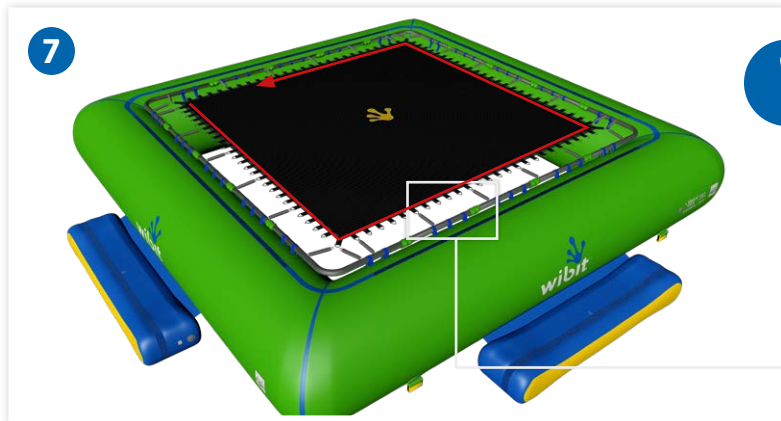

Attach 1 spring every 5 loops working around the Trampoline until all springs are installed, so that the jumping mat is put under tension equally from all sides.

- Proceed with adding more springs

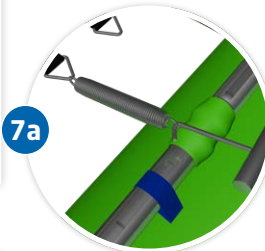

- Use the same procedure working your way around the frame



- Add the remaining springs



- Cover the springs with the safety pad
- Fasten the safety pad to the frame using the lace and make sure the blue velcro on the safety pad lines up with the velcro on the tube

FLIP

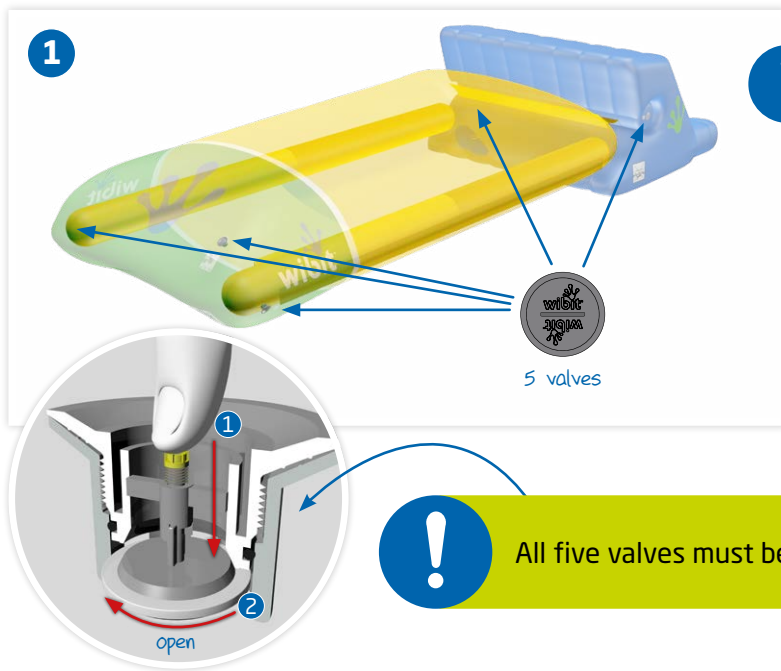

! It is important to follow the right order when inflating the different air chambers!

Air chambers:

1. blue body
2. blue tube
3. yellow pillow
4. inner tubes

! All five valves must be opened before inflating the Flip!



- Inflate the blue body up to 100%

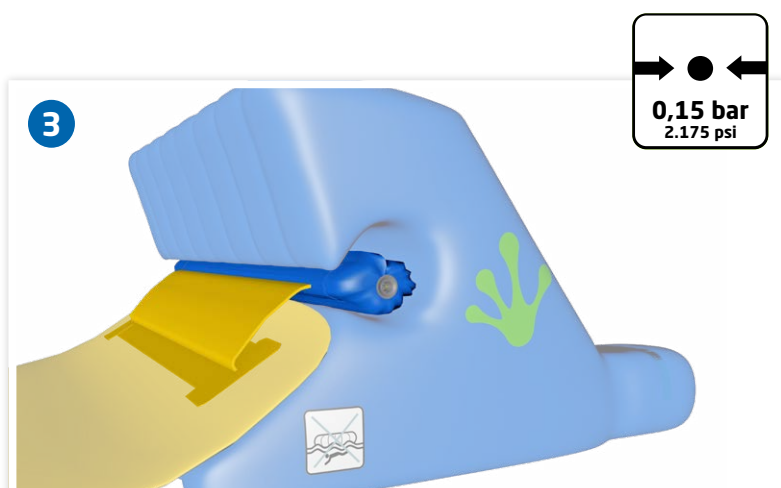

- Position the uninflated blue tube in the center of the blue body
- Inflate the blue tube up to 100% while making sure it stays in the center of the blue body
- Make sure to regularly refill the blue tube to assure it stays in the center

2. SPECIAL PRODUCT SETUP

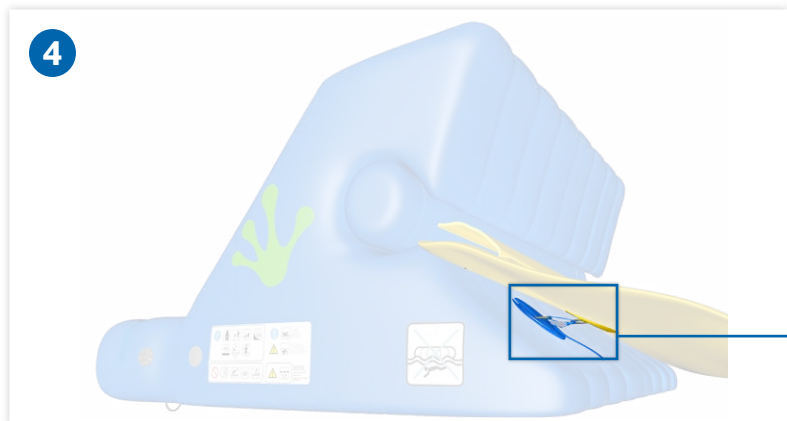

- Loosely connect the pillow with the blue body using the connector strap



- Inflate the yellow pillow **only up to 65-75%** in order to avoid damage!

! Do not fully inflate the yellow pillow!

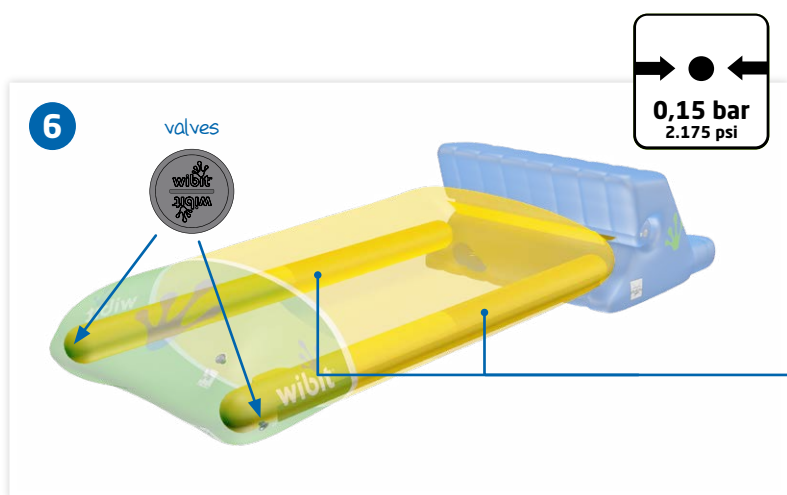

- Inflate the two inner tubes up to 100%



L-CONNECT (SUS) AND R-CONNECT (SUS)

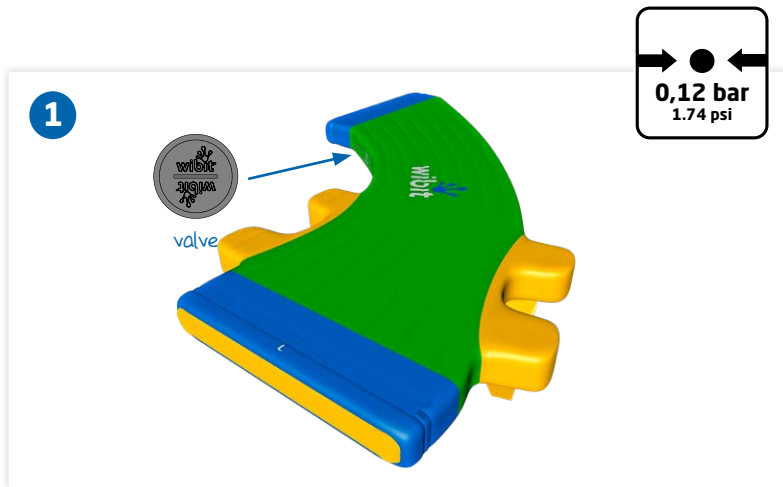

- Inflate the L-Connect (SUS) up to 100%

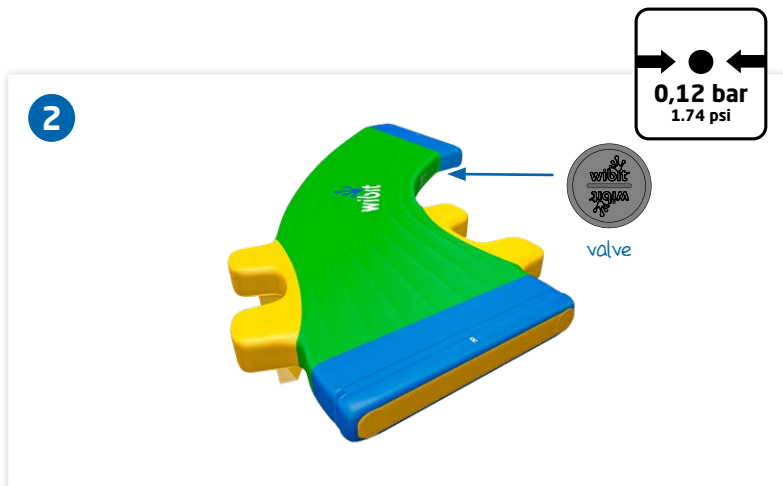

- Inflate the R-Connect (SUS) up to 100%

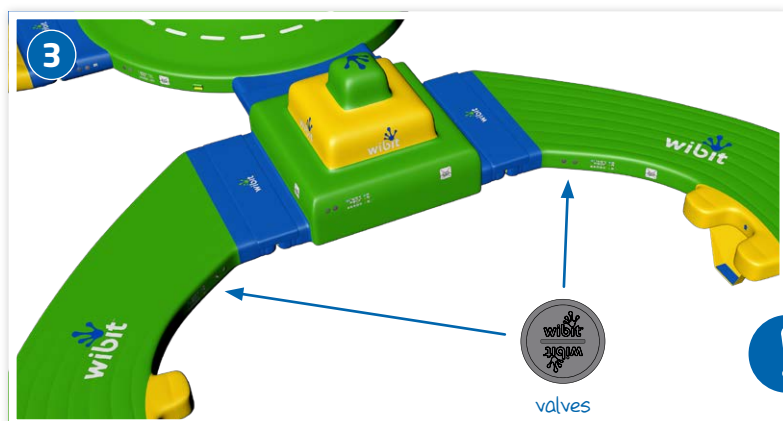

- For our standard infinity shape, connect the blue section of the L- and R-Connect (SUS) next to the valve, to the blue section of the Deck (3), Junction or T-Connect (SUS). So that both valves are located on the inside of the loop



Please refer to your *Anchor Plan* to make sure the L- and R-Connect (SUS) are installed correctly.

SPRINGBOARD



! It is important to follow the right order when inflating the different air chambers!

Air chambers:

1. main body
2. lower podest
3. blue sections
4. yellow tubes

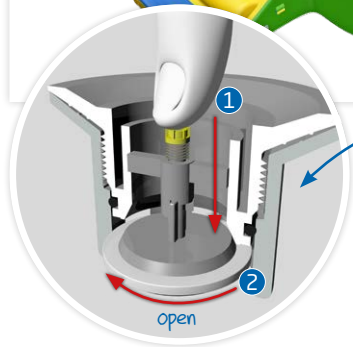

! All valves must be opened before inflating the Springboard!

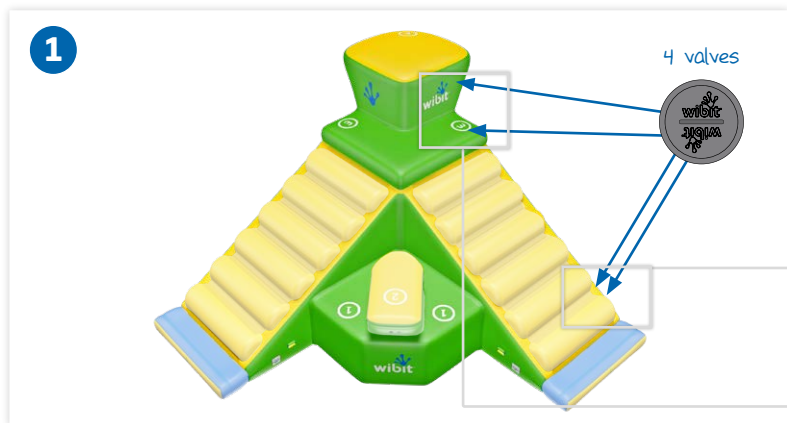

• Inflate the main body up to 100%

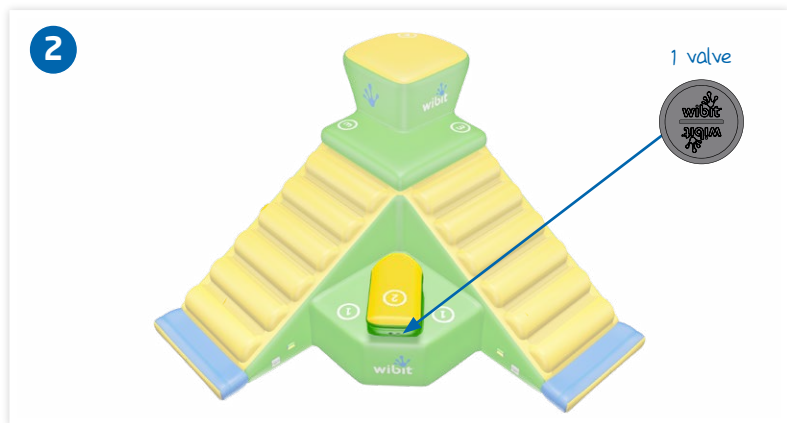

• Inflate the lower podest up to 100%

2. SPECIAL PRODUCT SETUP

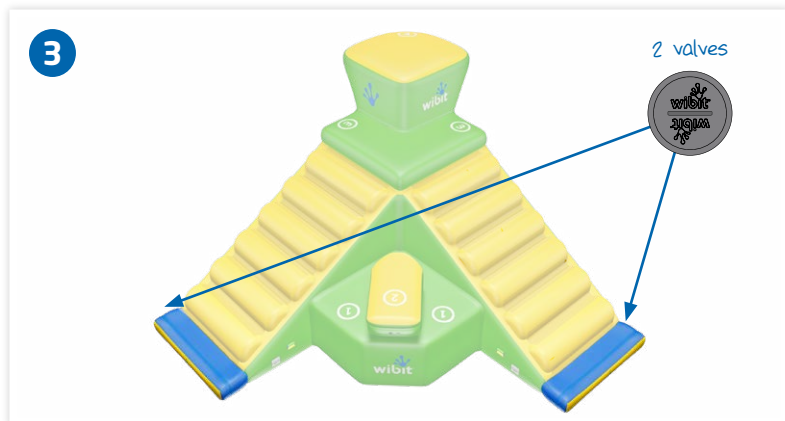

- Inflate the blue sections up to 100%

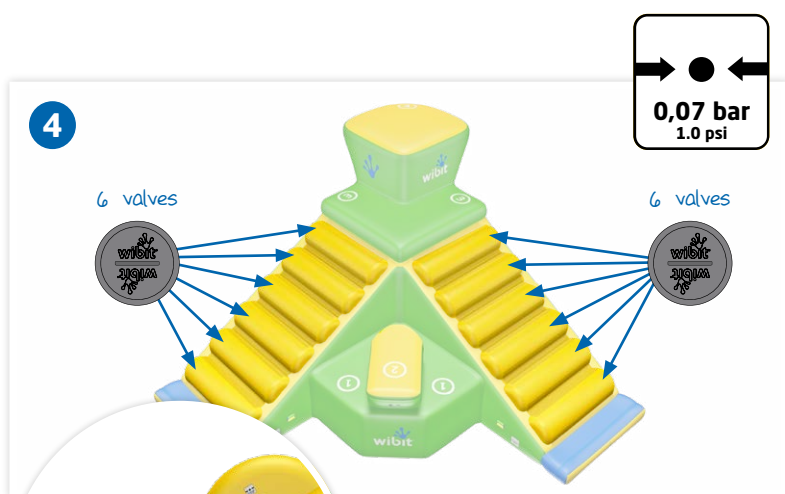

- Please inflate the yellow tubes up to 0,07 bar / 1.0 psi air pressure!

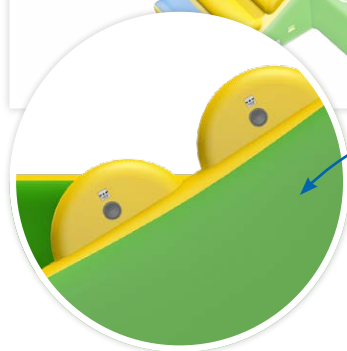

Every yellow tube has its own valve!

WIGGLEDISCS & WIGGLE START BLOCK NM



Inflation FlatTop™

Wibit FlatTop™ products require a high working pressure that can only be reached using the Wibit hand pump. Make sure to inflate the Wigglediscs up to a working pressure of 0,5 bars / 7.25 psi and the Wiggle Start Block NM to 0,4 bars / 5.8 psi.

WiggleBridge connection



• Connector strap with carabiner

Make sure that you use the correct connector strap with carabiner on both ends.

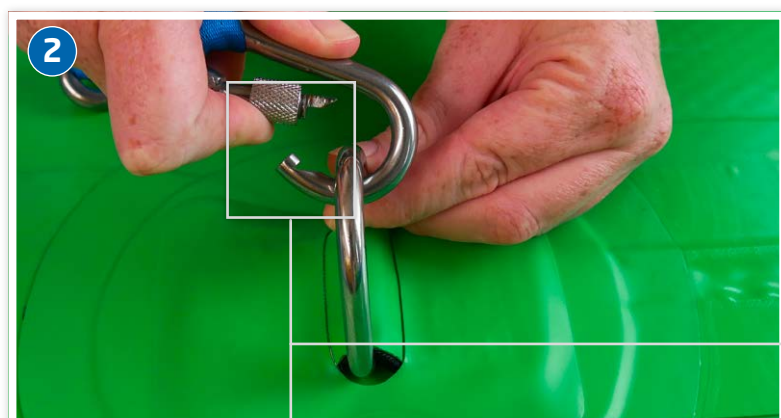

• Connection between carabiner and D-ring

Ensure to connect the carabiner with the D-ring of the anchor plate in the correct manner!



Attention: Close the safety lock completely and correctly! The safety lock is to be turned like a screw until fully closed.

STEP & STEP 6

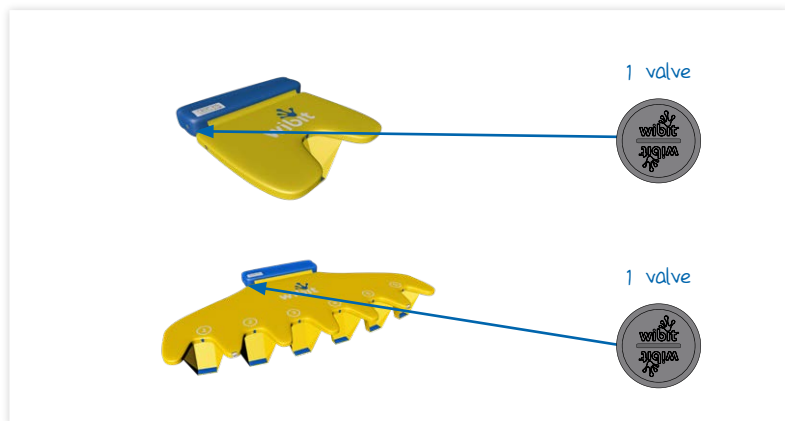

Inflation blue section

- Inflate the blue sections up to 100% using the electric pump.



Step inflation FlatTop™

Wibit FlatTop™ products require a high working pressure that can only be reached using the Wibit hand pump. Make sure to inflate the Step up to a working pressure of 0,5 bars / 7.25 psi.

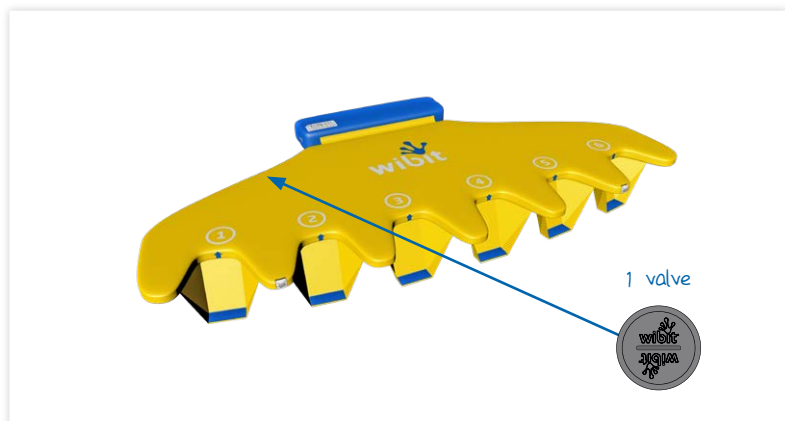

Step 6 inflation FlatTop™

Wibit FlatTop™ products require a high working pressure that can only be reached using the Wibit hand pump. Make sure to inflate the Step 6 up to a working pressure of 0,5 bars / 7.25 psi.

You can find important safety icons next to the valve on each product. Please pay special attention to the following icons:



- The required minimum water depth can be found next to the valve of each product and in the SPECIFICATIONS section at the end of this *Product Manual*

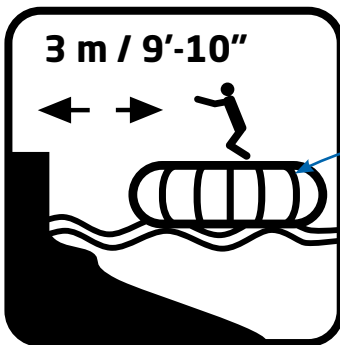

safety distance

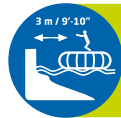

Make sure the minimum safety distance for each product is given at all times!

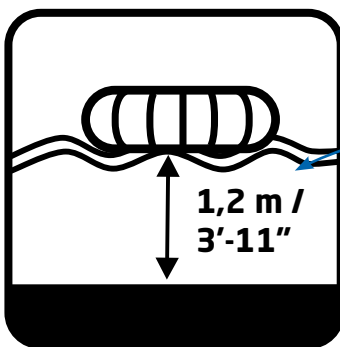

required min. water depth



Ensure that the minimum water depth for each product is given at all times!

There are several ways to anchor the products in a commercial pool. If you use bungees, please follow the following procedure:

BUNGEEES

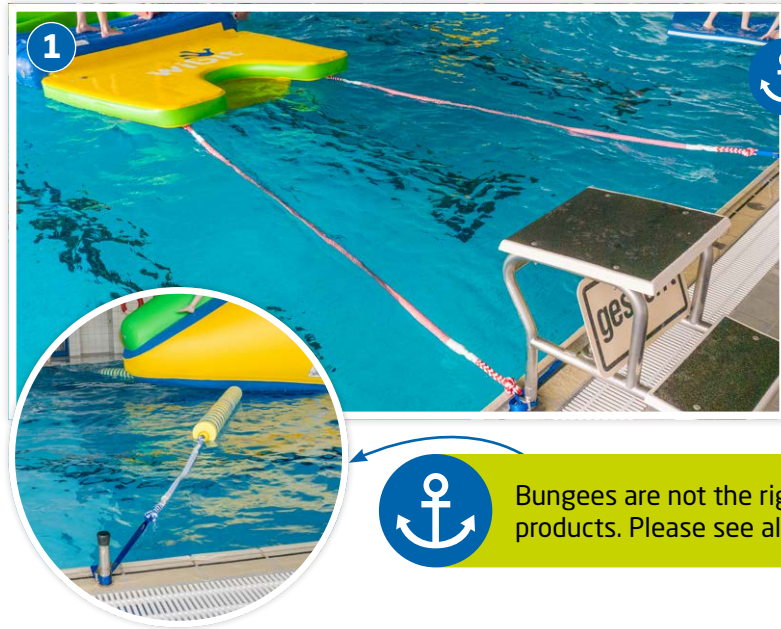

Make sure you use 3 m / 10' bungees for horizontal anchoring.



Bungees are not the right choice for high sliding and jumping products. Please see alternatives on the following pages.

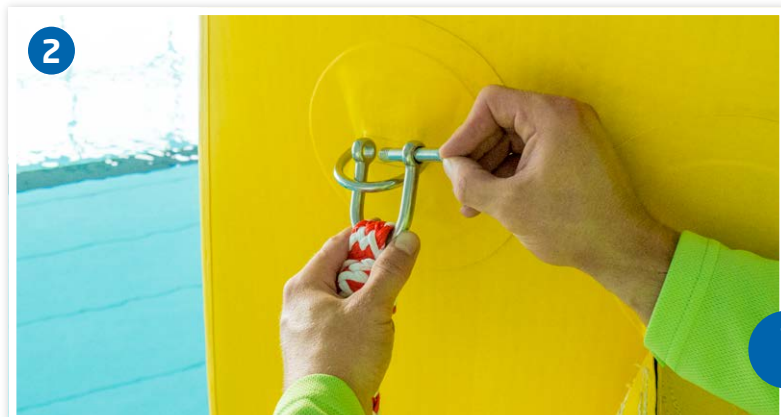

- Connect bungees to start and end product by using the shackle

Never open the knot of the bungee!

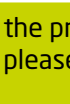

- Position the combination in the water
- Connect the bungee with the connector strap at poolside connection point
- Pull the strap until sufficient tension is achieved to hold the bungee in position

If the distance from the products to the pool connection point is more than 3 m / 10' please make sure to use the strap with loop (5 m / 16').



- If you need the extension with the strap with loop (5 m / 16'), connect this strap with the bungee first



To connect the strap (5 m / 16') to the pool connection point use the strap with double buckle.

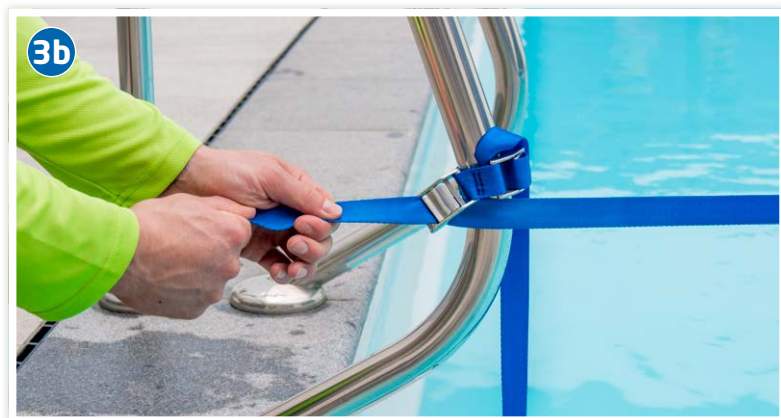

- Connect the strap (5 m / 16') with the second buckle
- Pull the strap (5 m / 16') until sufficient tension is achieved to hold the products in the correct position

3. ANCHORING

As an alternative to the horizontal anchoring with bungees, you may use pool booms or anchor sacks. Please note: ActionTower XL, Slope and RodeoSlide must only be anchored using pool booms or anchor sacks.

POOL BOOMS



Please check the *Product Manual* inside the pool booms packaging for more information!

ANCHOR SACKS



Please check the *Product Manual* inside the anchor sack packaging for more information!

The following instructions will help you to manage smaller repairs by yourself. We recommend to do any repairs in an air conditioned environment.



! If your product is losing pressure then make sure that the valve is not loose!

- Use the Wibit Multi-Tool for opening/closing/removing all types of Wibit valves and shackles



- Find puncture by spraying the product with soapy water



- Clean punctured area and PVC patch with acetone before glueing



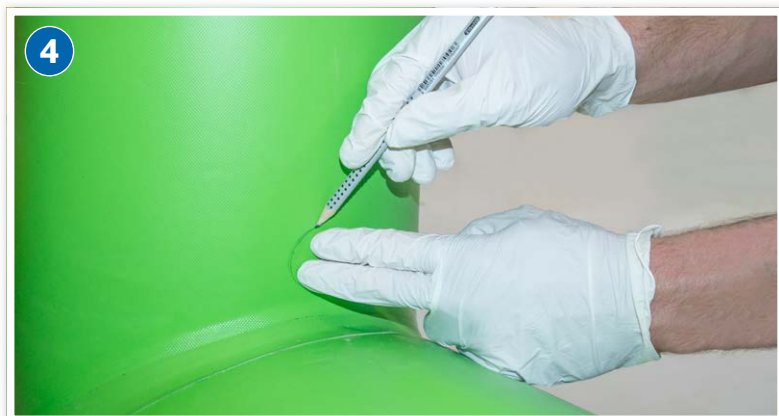

- Mark area with PVC patch using a pencil

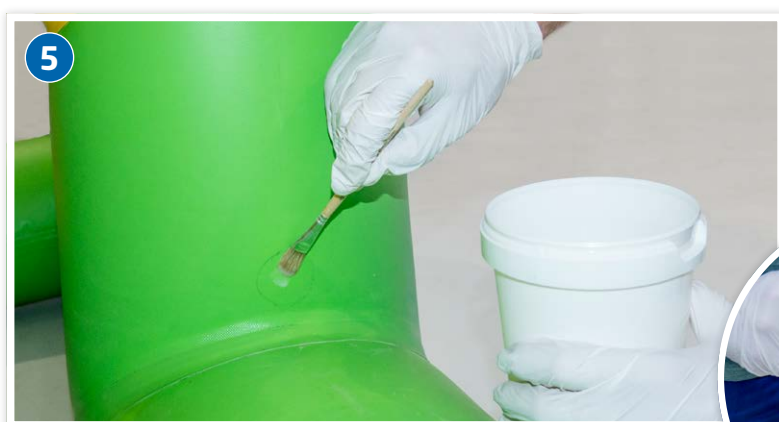

- Apply glue to the marked area and PVC patch and let it dry
- Make sure to wear rubber or work gloves (no bare hands)



Make sure that the temperature is not too hot!
The max. temperature is 80-90 °C / 176-194 °F!

- Use a heatgun to warm up the PVC patch and the product which reactivates the glue





- Press the PVC patch on marked area with flat tool from the center to the outside, making sure that no air is trapped underneath

Check out the following videos for further repairs:



5. CLEANING, FOLDING & STORAGE

To increase the lifespan and ensure proper function of the products we recommend that operators regularly check the products and clean them as necessary. It is best if you make this part of your daily routine before the pool opens.



1



Ask for more detailed information!

- Clean products regularly with clear water to avoid that the chlorine affects the PVC material



Before the products are put into storage it is extremely important that they are left to dry completely to prevent any formation of mold.



2

- Deflate the products completely using the electric pump until no air is left inside the products
- Fold the products accurately (at least two people needed)



scan QR Code to see video: Product folding

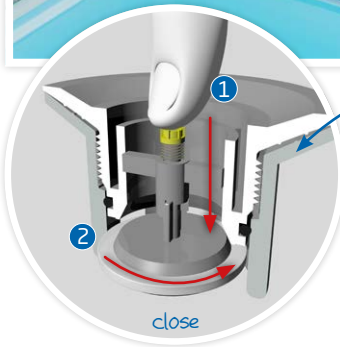

Close the valve before folding the products to make sure the vacuum is maintained.



3



Attention: Do not drag the products on the ground!



Dragging the products on the ground - especially when they are not inflated - may cause severe defects!



4



To make it easier for you to fold the products, we have created a *Folding Manual* and videos for you.

- Fold the products accurately (at least two people needed)
- Place the products in the transport bags



If you have enough storage space you can also leave your products inflated.



5



Tip: Keep all of your Wibit accessories (i.e. bungees, connector straps, pumps, repair kits, product manuals etc.) in a separate storage box.

- Store the product out of direct sunlight and protected from the environment in a clean, dry place away from any rodents
- Never store in a damp location or directly on concrete
- Never store at temperatures below 5°C/40°F or in an area with broad temperature fluctuations

6. PICTOGRAM EXPLANATION



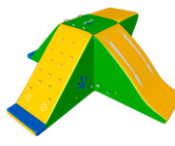
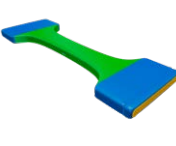
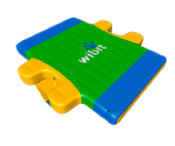
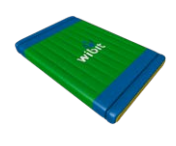

	Max. load capacity ...kg/lbs!		No diving!
	Max. numbers of users (children / adults)!		No protection against drowning!
	Size range: ...to... m/in body height!		Swimmers only!
	Kids size range: ...to... m/in body height!		Always supervise children in water!
	Ensure safe distance to dangerous obstacles ...m/ft!		Read instructions first!
	Minimum water depth of ...m/ft required!		Pool use only!
	Device provides floating stability!		Don't use when there are offshore winds!
	Device requires balancing!		Safe distance to the shore!
	Design working pressure ...bar/psi!		Don't use when there are offshore currents!
	Only for children aged 6 years and above (regular products)!		Do not swim underneath the structure!
	Only for children aged 4 years and above (kids products)!		Do not jump if landing area is not clear!

- FOR SWIMMERS ONLY!
- Product is stable for swimming!
- Do not exceed the admissible weight load stated on the type label!
- Uneven load distribution of persons or items can cause the product to capsize and must be avoided!
- Do not exceed the maximum number of users at any time as stated on the type label!
- Not suitable for users under 6 years (regular products) or 4 years (kids products)!
- The physique of users must not exceed the limits stated on the type label!
- Before use, always check that the water is sufficiently deep and the surrounding area of 3 m / 9'-10" free from rocks, sandbanks and people.
- Adherence to the prescribed minimum water depth during use is imperative!
- During "indoor use" (e.g. in indoor swimming pools), attention must be paid to a sufficient distance from the ceiling.
- Do not jump onto the product from other objects (e.g. from a springboard or similar) and do not jump from the product onto other objects!
- Swimming under the product is not permitted!
- Do not use in the dark!
- Ensure that the product has the correct air pressure at all times during use. Check the air pressure regularly on extremely hot/cold days!
- Ensure correct anchoring of the product before use!
- Do not use in strong currents or winds!
- Never use the product in strong winds, unsettled waters and thunderstorms. Remove the product from the water and secure in a suitable manner if the wind exceeds "Beaufort 5".
- Do not use the product in waters with natural risks (e.g. sharks, other animals, currents).
- Before all use, check the product for worn, defective or missing parts and replace these.
- The product is not designed as a rescue float and does not offer protection against drowning!
- Parents must supervise children during use!
- Remove necklaces, watches, rings and other sharp items before use!
- Failure to comply with the operating instructions can result in serious risks!
- The operating instructions must be accessible by the supervisory personnel!
- Difficult to mount for non-trained persons! We recommend the use of Wibit Step or a Wibit SUS (step up system) product as a mounting aid!
- The climbing rope must be fixed securely in the envisaged position at all times!
- Loops or similar in the rope must be removed.
- Do not enter or stand in the water in the jumping/safety area!
- Observe the sequence for setting up as per the operating instructions to ensure correct functioning of the product.
- Only one person must slide/jump at the same time!
- Only slide/jump when the safety area is free of persons!
- Sliding position: feet first
- To avoid danger, it is imperative that you follow the instructions of the supervisory personnel.

8. SPECIFICATIONS

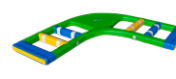

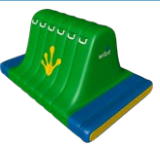
3D picture					
product name	ActionTower XL	ActionTower XXL	BalanceBeam	Base SUS	Base
item no.	30000	30001	30002	30131	30003
dimensions in ft (L x W x H)	14'-9" x 12'-10" x 6'-7"	29'-10" x 24'-11" x 9'-10"	19'-8" x 6'-7" x 1'	9'-10" x 9'-6" x 1'	9'-10" x 6'-7" x 1'
dimensions in m (L x W x H)	4,5 x 3,9 x 2	9,1 x 7,6 x 3	6 x 2 x 0,3	3 x 2,9 x 0,3	3 x 2 x 0,3
min. water depth in ft	6'-2"	7'-10"	3'-11"	3'-11"	3'-11"
min. water depth in m	1,9	2,4	1,2	1,2	1,2
includes	4x bungee	4x bungee	-	-	-
inflation time in min	17	30	2	4	3
user capacity	4	8	4	4	4
working pressure in psi	0.725	0.363	1.74	1.74	1.74
	2.175 (blue section)	2.175 (blue section)	-	-	-
	-	-	-	-	-
working pressure in bar	0,05	0,025	0,12	0,12	0,12
	0,15 (blue section)	0,15 (blue section)	-	-	-
	-	-	-	-	-
pressure relief valve colour	grey	violet	blue	blue	blue
	blue (blue section)	blue (blue section)	-	-	-
net weight in lbs	240	672	95	106	79
net weight in kg	109	305	43	48	36

specifications subject to change without notice



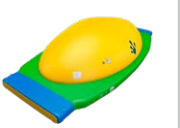
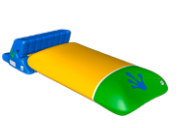

3D picture					
product name	Bend	Bridge	Cliff	Curve	Deck 3
item no.	301557	30013	30014	30016	30147
dimensions in ft (L x W x H)	18' x 18' x 12"	9'-10" x 6'-7" x 3'-11"	9'-10" x 6'-7" x 4'-11"	18'-1" x 18'-1" x 3'-7"	8'-6" x 9'-10" x 5'-3"
dimensions in m (L x W x H)	5,5 x 5,5 x 0,3	3 x 2 x 1,2	3 x 2 x 1,5	5,5 x 5,5 x 1,1	2,6 x 3 x 1,6
min. water depth in ft	3'-11"	4'-11"	5'-6"	4'-11"	5'-7"
min. water depth in m	1,2	1,5	1,65	1,5	1,7
includes	1x bungee	-	-	1x bungee	1x bungee
inflation time in min	5	3	7	12	7
user capacity	3	4	4	6	4
working pressure in psi	1.74	1.74	1.45	1.088	1.088
	-	-	-	-	-
	-	-	-	-	-
working pressure in bar	0,12	0,12	0,1	0,075	0,075
	-	-	-	-	-
	-	-	-	-	-
pressure relief valve colour	-	-	yellow	pink	pink
	-	-	-	-	-
net weight in lbs	110	77	115	254	132
net weight in kg	50	35	52	115	60

specifications subject to change without notice

8. SPECIFICATIONS

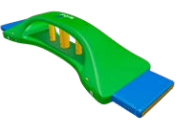

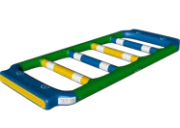
3D picture					
product name	Deck	DipBars	Dome	Flip	GuardTower
item no.	30017	30156	30078	30019	30074
dimensions in ft (L x W x H)	9'-10" x 9'-10" x 5'-3"	9'-10" x 19'-8" x 4'-3"	19'-8" x 9'-10" x 4'-3"	19' x 6'-7" x 3'-7"	19'-8" x 9'-10" x 13'-1"
dimensions in m (L x W x H)	3 x 3 x 1,6	3 x 2 x 1,3	6 x 3 x 1,3	5,8 x 2 x 1,1	6 x 3 x 4
min. water depth in ft	5'-7"	5'-3"	5'-11"	6'-7"	6'-2"
min. water depth in m	1,7	1,6	1,8	2	1,9
includes	1x bungee	-	1x bungee	1x bungee	3x bungee
inflation time in min	7	3	12	8	16
user capacity	4	2	2	2	3
working pressure in psi	1.088	1.74	1.45	1.74	1.088
	-	-	80-90 % (pillow)	2.175 (inner tubes)	2.175 (side walls)
	-	-	-	65-75 % (pillow)	2.175 (tubes)
working pressure in bar	0,075	0,12	0,1	0,12	0,075
	-	-	80-90 % (pillow)	0,15 (inner tubes)	0,15 (side walls)
	-	-	-	65-75 % (pillow)	0,15 (tubes)
pressure relief valve colour	pink	blue	yellow	blue	pink
	-	-	-	-	blue (side walls)
net weight in lbs	141	100	229	165	392
net weight in kg	64	45	104	75	178

specifications subject to change without notice



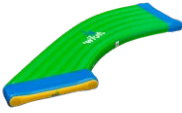

3D picture					
product name	Halfpipe	HighRoller	Hop	Hurdle	Junction
item no.	30101	30073	30159	30079	30025
dimensions in ft (L x W x H)	9'-10" x 13'-1" x 3'-11"	29'-6" x 8'-10" x 5'-3"	9'-10" x 6'-7" x 3'-3"	19'-8" x 8'-2" x 11"	9'-10" x 9'-10" x 11"
dimensions in m (L x W x H)	3 x 4 x 1,2	9 x 2,7 x 1,6	3 x 2 x 1	6 x 2,5 x 0,3	3 x 3 x 0,3
min. water depth in ft	4'-11"	5'-7"	4'-7"	3'-11"	3'-11"
min. water depth in m	1,5	1,7	1,4	1,2	1,2
includes	2x bungee	2x bungee	-	-	1x bungee
inflation time in min	8	13	3	2	3
user capacity	6	4	2	2	4
working pressure in psi	1.088	1.45	1.74	1.74	1.74
	2.175 (blue section)	2.175 (tubes)	-	-	-
	-	1.74 (blue section)	-	-	-
working pressure in bar	0,075	0,1	0,12	0,12	0,12
	0,15 (blue section)	0,15 (tubes)	-	-	-
	-	0,12 (blue section)	-	-	-
pressure relief valve colour	pink	yellow	blue	-	blue
	blue (blue section)	blue (blue section)	-	-	-
net weight in lbs	198	273	66	70	115
net weight in kg	90	124	30	32	52

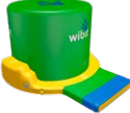
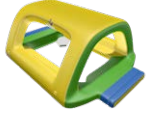
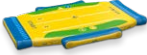
specifications subject to change without notice

8. SPECIFICATIONS

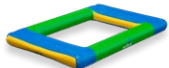

3D picture					
product name	L-Connect	L-Connect SUS	Ledge	MonkeyBars	Oval
item no.	30107	30135	30130	30072	30030
dimensions in ft (L x W x H)	18'-1" x 13'-1" x 11"	18'-1" x 14'-5" x 11"	14'-9" x 12'-10" x 8'-10"	19'-8" x 13'-1" x 6'-11"	15'-1" x 9'-10" x 1'
dimensions in m (L x W x H)	5,5 x 4 x 0,3	5,5 x 4,4 x 0,3	4,5 x 3,9 x 2,7	6 x 4 x 2,1	4,6 x 3 x 0,3 m
min. water depth in ft	3'-11"	3'-11"	4'-1"	5'-7"	3'-11"
min. water depth in m	1,2	1,2	1,25	1,7	1,2
includes	1x bungee	1x bungee	2x bungee	2x bungee	1x bungee
inflation time in min	3	3	24	11	15
user capacity	6	6	4	4	6
working pressure in psi	1.74	1.74	0.36	1.088	1.45
	-	-	1.74 (bottom part)	-	-
	-	-	-	-	-
working pressure in bar	0,12	0,12	0,025	0,075	0,1
	-	-	0,12 (bottom part)	-	-
	-	-	-	-	-
pressure relief valve colour	blue	blue	violet	pink	yellow
	-	-	blue (bottom part)	-	-
net weight in lbs	159	179	265	381	168
net weight in kg	72	81	120	173	76

specifications subject to change without notice

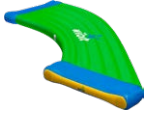

3D picture					
product name	Peak	Plank	Podium	Pond	Quarterpipe
item no.	30129	30161	30031	30033	30100
dimensions in ft (L x W x H)	19'-8" x 10'-6" x 8'-6"	19'-8" x 6'-7" x 3'-11"	9'-10" x 8'-2" x 2'-4"	9'-10" x 6'-7" x 1'	19'-8" x 8'-10" x 4'-7"
dimensions in m (L x W x H)	6 x 3,2 x 2,6	6 x 2 x 1,19	3 x 2,5 x 0,7 m	3 x 2 x 0,3 m	6 x 2,7 x 1,4
min. water depth in ft	7'-3"	4'-11"	4'-3"	3'-11"	5'-3"
min. water depth in m	2,2	1,5	1,3	1,2	1,6
includes	2x bungee	-	-	-	2x bungee
inflation time in min	14	10	15	1	9
user capacity	4	3	4	4	6
working pressure in psi	1.088	1.45	1.74	1.74	1.088
	1.74 (bottom part)	7.25 (flattop)	-	-	2.175 (blue section)
	-	1.74 (tubes)	-	-	-
working pressure in bar	0,075	0,1	0,12	0,12	0,075
	0,12 (bottom part)	0,5 (flattop)	-	-	0,15 (blue section)
	-	0,12 (tubes)	-	-	-
pressure relief valve colour	pink	blue	blue	blue	pink
	-	-	-	-	blue (blue section)
net weight in lbs	280	181	77	46	267
net weight in kg	127	82	35	21	121

specifications subject to change without notice

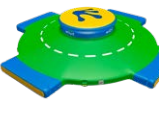
8. SPECIFICATIONS





3D picture					
product name	R-Connect SUS	R-Connect	Rock	RodeoSlide	Roundabout
item no.	30136	30108	30123	30102	30087
dimensions in ft (L x W x H)	18'-1" x 14'-5" x 1'	18'-1" x 13'-1" x 1'	22'-4" x 19'-8" x 10'-2"	12'-2" x 6'-11" x 5'-3"	19'-8" x 19'-8" x 3'-11"
dimensions in m (L x W x H)	5,5 x 4,4 x 0,3	5,5 x 4 x 0,3	6,8 x 6 x 3,1	3,7 x 2,1 x 1,6	6 x 6 x 1,2
min. water depth in ft	3'-11"	3'-11"	7'-10"	5'-7"	4'-11"
min. water depth in m	1,2	1,2	2,4	1,7	1,5
includes	1x bungee	1x bungee	4x bungee	1x bungee	1x bungee
inflation time in min	3	3	25	7	13
user capacity	6	6	6	2	6
working pressure in psi	1.74	1.74	1.088	0.9	1.088
	-	-	2.175 (blue section)	2.175 (tube)	1.74 (blue section)
	-	-	-	2.175 (blue section)	-
working pressure in bar	0,12	0,12	0,075	0,06	0,075
	-	-	0,15 (blue section)	0,15 (tube)	0,12 (blue section)
	-	-	-	0,15 (blue section)	-
pressure relief valve colour	blue	blue	pink	grey	pink
	-	-	-	blue	blue (blue section)
net weight in lbs	179	159	608	130	348
net weight in kg	81	72	276	59	158

specifications subject to change without notice





3D picture					
product name	SideKick	Sidewalk	Slide	Slope	Spin
item no.	30040	30109	30042	30044	30158
dimensions in ft (L x W x H)	8'-2" x 8'-2" x 1'	29'-6" x 9'-10" x 1'	9'-10" x 6'-7" x 3'-7"	9'-10" x 6'-7" x 4'-11"	19'-8" x 12'-1" x 12'-1"
dimensions in m (L x W x H)	2,5 x 2,5 x 0,3	9 x 3 x 0,3	3 x 2 x 1,1	3 x 2 x 1,5	6 x 4 x 4
min. water depth in ft	3'-11"	3'-11"	4'-11"	5'-6"	4'-7"
min. water depth in m	1,2	1,2	1,5	1,65	1,4
includes	1x bungee	2x bungee	-	2x bungee	2x bungee
inflation time in min	3	8	3	6	15
user capacity	4	12	4	4	4
working pressure in psi	1.74	1.74	1.45	0.725	1.45
	-	-	-	-	1.74 (green parts)
	-	-	-	-	-
working pressure in bar	0,12	0,12	0,1	0,05	0,1
	-	-	-	-	0,12 (green parts)
	-	-	-	-	-
pressure relief valve colour	blue	blue	yellow	grey	yellow
	-	-	-	-	-
net weight in lbs	51	229	93	106	302
net weight in kg	23	104	42	48	137

specifications subject to change without notice

8. SPECIFICATIONS

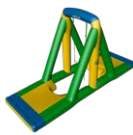
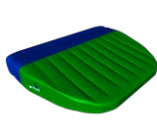

3D picture					
product name	Springboard	StartGate SUS	Start Gate	Step	Step 6
item no.	30120	30132	30071	30104	30110
dimensions in ft (L x W x H)	19'-8" x 19'-8" x 10'-6"	19'-8" x 10'-6" x 10'-2"	19'-8" x 9'-2" x 9'-6"	6'-7" x 6'-7" x 1'	20'-8" x 9'-10" x 1'
dimensions in m (L x W x H)	6 x 6 x 3,2	6 x 3,2 x 3,1	6 x 2,8 x 2,9	2 x 2 x 0,3	6,3 x 3 x 0,3
min. water depth in ft	8'-2"	3'-11"	3'-11"	3'-11"	3'-11"
min. water depth in m	2,5	1,2	1,2	1,2	1,2
includes	3x bungee	2x bungee	2x bungee	-	2x bungee
inflation time in min	20	4	4	1	6
user capacity	8	8	4	2	6
working pressure in psi	0.725	1.74	1.74	2.175	2.175
	2.175 (blue sections, tubes, lower & upper platform)	2.175 (tubes)	2.175 (tubes)	7.25 (FlatTop™)	7.25
	-	-	-	-	-
working pressure in bar	0,05	0,12	0,12	0,15	0,15
	0,15 (blue sections, tubes, lower & upper platform)	0,15 (tubes)	0,15 (tubes)	0,5 (FlatTop™)	0,5
	-	-	-	-	-
pressure relief valve colour	grey	blue	blue	-	-
	blue	-	-	-	-
net weight in lbs	703	269	262	73	183
net weight in kg	319	122	119	33	83

specifications subject to change without notice



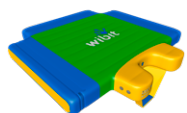

3D picture					
product name	Sun Shade	SUP Dock	Swing	TakeOff	Target
item no.	30083	30082	30047	30142	30121
dimensions in ft (L x W x H)	9'-10" x 11'-10" x 10'-2"	14'-9" x 13'-1" x 1'	19'-8" x 6'-7" x 10'-6"	6'-7" x 4'-11" x 1'	19'-8" x 17'-9" x 1'
dimensions in m (L x W x H)	3 x 3,6 x 3,1	4,5 x 4 x 0,3	6 x 2 x 3,2	2 x 1,5 x 0,3	6 x 5,4 x 0,3
min. water depth in ft	3'-11"	3'-11"	5'-11"	3'-11'	3'-11"
min. water depth in m	1,2	1,2	1,8	1,2	1,2
includes	1x bungee	1x bungee	-	-	1x bungee
inflation time in min	3	2	8	2	10
user capacity	4	6	4	2	4
working pressure in psi	1.74	1.74	1.74	1.45	1.74
	2.175 (tubes)	-	7.25 (FlatTop™)	-	2.175 (tubes)
	-	-	-	-	-
working pressure in bar	0,12	0,12	0,12	0,1	0,12 (middle part)
	0,15 (tubes)	-	0,5 (FlatTop™)	-	0,15 (tubes)
	-	-	-	-	-
pressure relief valve colour	blue	blue	blue	yellow	blue
	-	-	-	-	-
net weight in lbs	168	143	207	40	152
net weight in kg	76	65	94	18	69

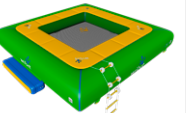
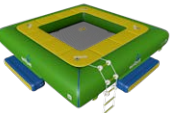
specifications subject to change without notice

8. SPECIFICATIONS

3D picture					
product name	T-Connect SUS	T-Connect	T-Connect with Step	Trampoline 2	Trampoline 4
item no.	30134	30075	30106	30050	30080
dimensions in ft (L x W x H)	9'-10" x 9'-10" x 1'	9'-10" x 8'-2" x 1'	9'-10" x 8'-2" x 1'	19'-8" x 16'-5" x 2'-11"	19'-8" x 19'-8" x 2'-11"
dimensions in m (L x W x H)	3 x 3 x 0,3	3 x 2,5 x 0,3	3 x 2,5 x 0,3	6 x 5 x 0,9	6 x 6 x 0,9
min. water depth in ft	3'-11"	3'-11"	3'-11"	8'-2"	8'-2"
min. water depth in m	1,2	1,2	1,2	2,5	2,5
includes	1x bungee	1x bungee	1x bungee	1x bungee	1x bungee
inflation time in min	3	3	3	13	15
user capacity	4	4	4	3	3
working pressure in psi	1.74	1.74	1.74	1.16	1.16
	-	-	-	2.175 (blue section)	2.175 (blue section)
	-	-	-	-	-
working pressure in bar	0,12	0,12	0,12	0,08	0,08
	-	-	-	0,15 (blue section)	0,15 (blue section)
	-	-	-	-	-
pressure relief valve colour	blue	blue	blue	-	-
	-	-	-	-	-
net weight in lbs	110	110	110	452	514
net weight in kg	50	50	50	205	233

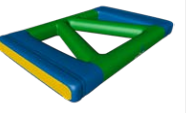
specifications subject to change without notice

3D picture					
product name	Turn SUS	Turn	Twist	V-Connect	WiggleBridge StartBlocks (2x)
item no.	30137	30122	30128	30105	30062
dimensions in ft (L x W x H)	18'-1" x 18'-1" x 1'	18'-1" x 18'-1" x 1'	19'-8" x 7'-7" x 2'-1"	9'-10" x 6'-7" x 1'	6'-7" x 4'-11" x 1'
dimensions in m (L x W x H)	5,5 x 5,5 x 0,3	5,5 x 5,5 x 0,3	6 x 2,3 x 0,64	3 x 2 x 0,3	2 x 1,5 x 0,3
min. water depth in ft	3'-11"	3'-11"	3'-11"	3'-11"	3'-11'
min. water depth in m	1,2	1,2	1,2	1,2	1,2
includes	1x bungee	1x bungee	-	-	-
inflation time in min	10	10	4	1	4 (2 per block)
user capacity	6	6	4	2	4 (2 per block)
working pressure in psi	1.74	1.74	2.17	1.74	1.45
	-	-	-	-	-
	-	-	-	-	-
working pressure in bar	0,12	0,12	0,15	0,12	0,1
	-	-	-	-	-
	-	-	-	-	-
pressure relief valve colour	blue	blue	blue	-	yellow
	-	-	-	-	-
net weight in lbs	207	205	126	51	75 (37,5 per block)
net weight in kg	94	93	57	23	34 (17 per block)

specifications subject to change without notice

8. SPECIFICATIONS





3D picture					
product name	WiggleDiscs (3x)	Y-Connect	Base blue	DoubleBase SUS blue	Junction blue
item no.	30060	30076	30095	30133	30094
dimensions in ft (L x W x H)	3'-3" x 3'-3" x 4"	10'-2" x 10'-2" x 1'	9'-10" x 6'-7" x 1'	19'-8 x 9'-6" x 1'	9'-10" x 9'-10" x 1'
dimensions in m (L x W x H)	1 x 1 x 0,1	3,1 x 3,1 x 0,3	3 x 2 x 0,3	6 x 2,9 x 0,3	3 x 3 x 0,3
min. water depth in ft	3'-11'	3'-11"	3'-11"	3'-11"	3'-11"
min. water depth in m	1,2	1,2	1,2	1,2	1,2
includes	-	1x bungee	-	1x bungee	1x bungee
inflation time in min	3 (1 per disc)	2	3	3	3
user capacity	3 (1 per disc)	4	4	6	4
working pressure in psi	7.25	1.74	1.74	1.74	1.74
	-	-	-	-	-
	-	-	-	-	-
working pressure in bar	0,5	0,12	0,12	0,12	0,12
	-	-	-	-	-
	-	-	-	-	-
pressure relief valve colour	-	blue	blue	blue	blue
	-	-	-	-	-
net weight in lbs	40 (13,33 per disc)	93	106	212	115
net weight in kg	18 (6 per disc)	42	48	96	52

specifications subject to change without notice

3D picture					
product name	L-Sidewalk SUS blue	R-Sidewalk SUS blue	SideKick blue	Sidewalk blue	Step blue
item no.	30138	30139	30154	30091	30112
dimensions in ft (L x W x H)	29'-6" x 9'-10" x 1'	29'-6" x 9'-10" x 1'	8'-2" x 8'-2" x 1'	29'-6" x 9'-10" x 1'	6'-7" x 6'-7" x 1'
dimensions in m (L x W x H)	9 x 3 x 0,3	9 x 3 x 0,3	2,5 x 2,5 x 0,3	9 x 3 x 0,3	2 x 2 x 0,3
min. water depth in ft	3'-11"	3'-11"	3'-11"	3'-11"	3'-11"
min. water depth in m	1,2	1,2	1,2	1,2	1,2
includes	2x bungee	2x bungee	1x bungee	2x bungee	-
inflation time in min	8	8	3	8	3
user capacity	12	12	4	12	2
working pressure in psi	1.74	1.74	1.74	1.74	2.175
	-	-	-	-	7.25 (FlatTop™)
	-	-	-	-	-
working pressure in bar	0,12	0,12	0,12	0,12	0,15
	-	-	-	-	0,5 (FlatTop™)
	-	-	-	-	-
pressure relief valve colour	blue	blue	blue	blue	-
	-	-	-	-	-
net weight in lbs	229	229	51	229	73
net weight in kg	104	104	23	104	33





specifications subject to change without notice

8. SPECIFICATIONS

3D picture					
product name	V-Connect blue	W-Connect blue	Wedge	Wedge blue	Junction blue
item no.	30092	30093	30127	30077	30094
dimensions in ft (L x W x H)	9'-10" x 6'-7" x 1'	19'-8" x 6'-7" x 1'	6'-7" x 4'-11" x 1'	6'-7" x 4'-11" x 1'	9'-10" x 9'-10" x 1'
dimensions in m (L x W x H)	3 x 2 x 0,3	6 x 2 x 0,3	2 x 1,5 x 0,3	2 x 1,5 x 0,3	3 x 3 x 0,3
min. water depth in ft	3'-11"	3'-11"	3'-11"	3'-11"	3'-11"
min. water depth in m	1,2	1,2	1,2	1,2	1,2
includes	-	-	-	-	1x bungee
inflation time in min	1	2	2	2	3
user capacity	2	2	2	2	4
working pressure in psi	1.74	1.74	1.74	1.74	1.74
	-	-	-	-	-
	-	-	-	-	-
working pressure in bar	0,12	0,12	0,12	0,12	0,12
	-	-	-	-	-
	-	-	-	-	-
pressure relief valve colour	-	-	blue	blue	blue
	-	-	-	-	-
net weight in lbs	53	72	51	51	115
net weight in kg	24	33	23	23	52





specifications subject to change without notice

KIDS PRODUCTS

3D picture					
product name	Cone	Connector	CrossOver	Downhill	Slip
item no.	33010	33014	33001	33005	33004
dimensions in ft (L x W x H)	12'-6" x 10'-10" x 3'-3"	9'-10" x 6'-7" x 11"	12'-6" x 3'-7" x 2'-7"	12'-6" x 9'-6" x 3'-3"	12'-6" x 8'-10" x 3'-3"
dimensions in m (L x W x H)	3,8 x 3,3 x 1	3 x 2 x 0,3	3,8 x 1,1 x 0,8	3,8 x 2,9 x 1	3,8 x 2,7 x 1
min. water depth in ft	3'-11"	3'-11"	4'-5"	4'-5"	4'-5"
min. water depth in m	1,2	1,2	1,35	1,35	1,35
includes	-	-	-	-	-
inflation time in min	3' 45"	1' 50"	2' 40"	5	5
user capacity	3	3	3	3	4
working pressure in psi	1.088	1.74	1.74	1.088	1.45
	-	-	1.74 (tubes)	1.74 (tubes)	-
	-	-	-	7.25 (railing)	-
working pressure in bar	0,075	0,12	0,12	0,075	0,1
	-	-	0,12 (tubes)	0,12 (tubes)	-
	-	-	-	0,5 (railing)	-
pressure relief valve colour	pink	blue	blue	pink	yellow
	-	-	-	-	-
net weight in lbs	121	62	71	137	137
net weight in kg	55	28	32	62	62

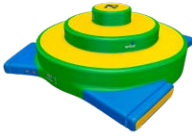
specifications subject to change without notice

8. SPECIFICATIONS

3D picture					
product name	Spiral	Step kids	TakeOff kids	T-Connect SUS kids	Y-Connect SUS kids
item no.	33002	33015	33011	33017	33016
dimensions in ft (L x W x H)	12'-6" x 10'-10" x 3'-3"	3'-3" x 2'-4" x 8"	3'-3" x 2' x 8"	6'-7" x 5'-7" x 8"	9'-2" x 5'-11" x 8"
dimensions in m (L x W x H)	3,8 x 3,3 x 1	1 x 0,7 x 0,2	1 x 0,6 x 0,2	2 x 1,7 x 0,2	2,8 x 1,8 x 0,2
min. water depth in ft	4'-5"	3'-11"	3'-11"	3'-11"	3'-11"
min. water depth in m	1,35	1,2	1,2	1,2	1,2
includes	-	-	-	-	-
inflation time in min	4	20"	20"	45"	1' 50"
user capacity	3	1	1	2	3
working pressure in psi	1.45	1.74	1.74	1.74	1.74
	-	-	-	-	-
	-	-	-	-	-
working pressure in bar	0,1	0,12	0,12	0,12	0,12
	-	-	-	-	-
	-	-	-	-	-
pressure relief valve colour	yellow	blue	blue	blue	blue
	-	-	-	-	-
net weight in lbs	115	13	13	35	55
net weight in kg	52	6	6	16	25

specifications subject to change without notice